

Methods of measuring and modelling geomagnetically induced currents (GICs) in a power line.

E Matandirotya^{1,2,3}, P J Cilliers^{1,2} and R R van Zyl^{2,3}

¹Cape Peninsula University of Technology, Bellville, South Africa

²South African National Space Agency(SANSA): Space Science , Hermanus, South Africa

³French South African Institute of Technology (F'SATI), Bellville, South Africa

E-mail: esiziba@sansa.org.za, electdom@gmail.com

Abstract. The implementation of proposed techniques for measuring and modelling geomagnetically induced currents (GICs) in power lines are discussed in this paper. GICs are currents in grounded conductors driven by an electric field produced by time varying magnetic fields linked to magnetospheric-ionospheric currents during magnetic storms. These currents can cause overheating and permanent damage to high voltage transformers in power systems. Measurements of GICs are done on the neutral to ground connections of transformers in some substations. There is a need to know the magnitude and direction of the GICs flowing on the power lines connected to the transformers. Direct measurements of GICs on the lines are not feasible due to the low frequencies of these currents which make current measurements using current transformers (CTs) impractical. Two methods are proposed to study the characteristics of GICs in power lines. The differential magnetic measurement (DMM) technique is an indirect method to calculate the GICs flowing in the power line. With the DMM method, low frequency GIC current in the power line is estimated from the difference between magnetic recordings made directly underneath the power line and at some distance away, where the natural geomagnetic field is still approximately the same as under the power line. An analysis of the spectrum of GICs, the DMM technique, and preliminary results are presented. Finite element (FE) modelling with COMSOL-Multiphysics software is implemented so that the nature of the return currents flowing on the power lines and the Earth's surface can be analysed. In order to develop the FE-model, historical geomagnetic data recorded at Hermanus and Earth conductivity values derived from literature are used as the modelling inputs to the FE model. Preliminary results of current density distributions obtained by means of FE modelling are also presented.

1. Introduction

Geomagnetically induced currents (GICs) are a major concern when grounded conductors are considered. GICs are an end product of adverse "space weather". The propagation of the solar winds from the Sun through the magnetosphere and the ionosphere results in magnetic field variations. This is due to the interactions of solar winds with the current systems of these space regions which yields geomagnetic storms. During a geomagnetic storm, time varying geomagnetic field on and beneath the Earth's surface are induced [1]. The geomagnetic field induces a geo-electric field and thus voltage differences are set between points on the surface of the Earth. The Earth has its own conductivity profile i.e. there will be spatial distribution of the current flow in the Earth. These currents which arise due to the voltage differences between

the ends of a grounded conductor can produce damage in the system attached to that conductor. The extent of damage depends on the particular system configuration [2].

Power systems, gas pipe lines, railway lines and telephone lines are technologies where the occurrence of these GICs has been noted and reported in [3, 4]. The focus of this paper is on power lines. With the daily dependence of human society on electricity, understanding the effects of GICs on power system has been at the center of GIC research. The aim is to improve the understanding of GICs in order to facilitate the management and mitigation of the impact of damages caused by the GICs on power systems. The presence of GICs in the power network initiates transformer saturations. Such saturations result in the increase of the excitation currents and disruption of the normal behavior of the transformers [5]. The overall damage may be observed as transformer heating, relay tripping and at worst case, a black out like the Hydro-Quebec 1989 incident [6].

GICs are currently measured in substations at the neutral to ground connections. Figure 1 shows typical GICs data recorded at the Grassridge substation (4-6 April 2010). A Fast Fourier Transform (FFT) performed on the data set indicates that GICs are low frequency currents with most of the energy in the GICs below 0.2 mHz. Figure 2 shows the amplitude spectrum of the Grassridge GIC data.

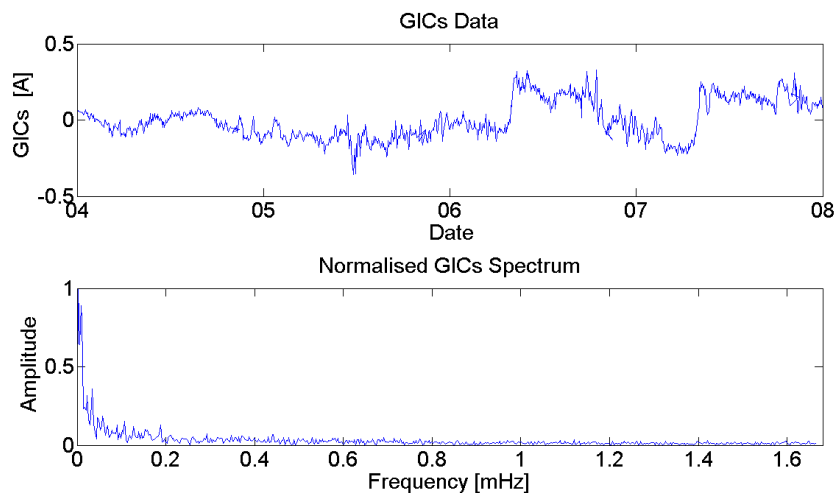

Figure 1. GIC data recorded during on 4-6 April 2010 at the Grassridge substation

However, there is need to know the magnitude of GICs flowing into the transformer. The power lines are the feeders of transformers so it makes sense to measure the GICs in the power lines for an overall comprehension of GICs flowing into the transformers. The paper discusses the approach proposed to achieve the GICs measurements on power lines. Due to the impracticality of direct GICs measurement using current transformers (CT), an indirect method is proposed. This method will be referred to as differential magnetic measurement (DMM) technique and it involves the use of two fluxgate magnetometers. This technique has been applied in the measurement of GICs in a 400 kV line in the Finland network and gas pipelines (since 1990s) [7].

At this point it is worth noting that the proposed measurements are to be done in a mid-latitude region. Unlike high latitude regions, mid and low latitude regions were believed to be less prone to GICs. However, mid- latitude regions such as Australia, Brazil, China, Spain, and South Africa have invested in measurements, recording, modelling GICs in the networks since a link between power grid mal-operation and adverse space weather events was established, see [8, 9, 10, 11, 12].

2. Differential magnetic measurements

The differential magnetic measurements technique will be implemented as an indirect way of measuring GICs on power lines. The technique comprises of simultaneous recordings by means of two identical magnetometers. The measurement concept assumes that one magnetometer under the power lines will measure both the natural Earth magnetic field and the magnetic field induced by GICs in the power line. The general set up is as shown in Figure 2, while Figure 3 illustrates the necessary components. The second magnetometer, placed at a distance from the first will measure the natural geomagnetic field only. The calculated difference between the measured fields will then be the contribution of the quasi-DC current flowing on the power lines. The GICs in the power lines can be inferred from the difference between the magnetic field measured under the power line and at some distance from the power line.

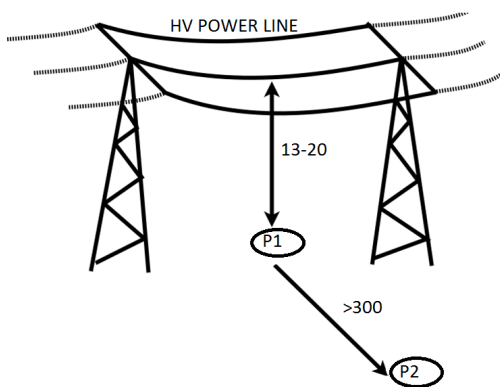

Figure 2. The magnetometer set-up for differential magnetometers

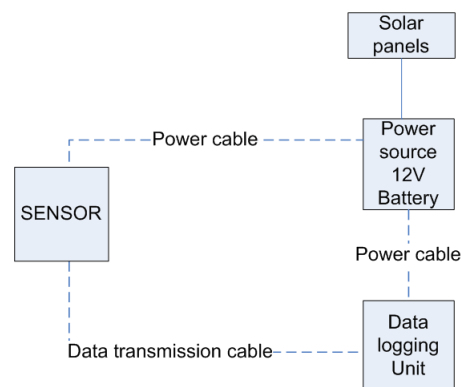

Figure 3. Components essential for the DMM technique

2.1. Site identification and environment

When selecting a site for GICs measurements, certain aspects need to be considered so as to enhance accuracy of the DMM and validity of the measured results.

- While very little or nothing can be done about the natural occurring field variations, an area with minimal man-made magnetic disturbances should be considered. This is to avoid magnetic interference from the man-made influence.
- It should also be possible to have a comparison of the GICs measured on the power lines as well as those from the transformer neutrals fed by the same power lines. GICs cannot be measured on some transformer neutrals as series capacitors are installed on the network [5]. The capacitors block the flow of GICs into the transformers and hence protect the network. The selected site should be a power line which terminates in non dc compensated substation.
- There should be minimum or negligible natural spatial variation of the geomagnetic field at the magnetometer placement positions. A set of measurements need to be carried out to validate this condition. Using magnetic field data measured in a quiet day (when there are no geo-magnetic disturbances), the spectral analysis through Fourier transforms can be used to infer the spatial uniformity of the geomagnetic field at the measurement positions. In this case similar frequency spectra will imply uniformity.
- Using historically measured GIC data from the South African power grid, a range of expected geomagnetic field can be calculated. If the estimated source current for a measured

magnetic field difference is the less than 1 % of the corresponding recorded GICs, the variation will be deemed negligible.

2.2. DMM technique preliminary results

The trial run of the technique was to test if the selected magnetometer and control instruments could operate under the power line. The anticipated challenge was the sensor saturation due to the 50 Hz component of the magnetic field. A setup was done under a power line connected to a non dc compensated substation which also complied with the listed conditions. The location is on a farm near Botriver where there is limited man made magnetic interference. Figure 4 illustrates the first set of measurements at the selected site. The variations shown in Figure 4 shows us that the magnetometer did not saturate in the vicinity of the power lines.

The recorded field variations were compared with recorded magnetic data from Hermanus. The Hermanus magnetic data recorded at the same time as at Botriver was extracted from the daily magnetic data. Though the x-component of the magnetic field variations exhibit a similar trend, the y- and the z- component are not. At this stage considering that this was a pre-test to test the equipment it sufficed to prove that the saturation of the instruments did not occur and that the 50 Hz component did not appear in the measured data. Longer period recordings will hence be done when high memory data loggers are available. Such data will also aid in the validation of the spatial uniformity of the geomagnetic field at the measurement site.

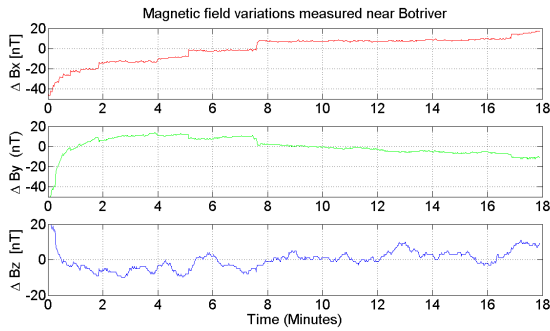

Figure 4. Magnetic field variations recorded at the chosen measurement site near Botriver

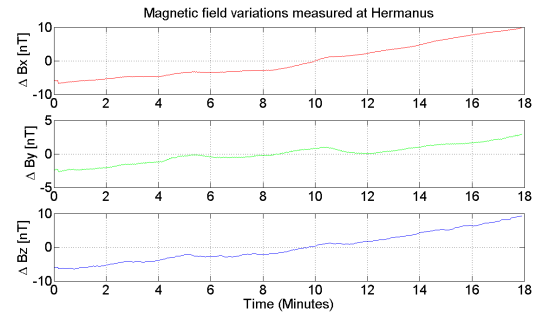

Figure 5. Magnetic field variations recorded at Hermanus at the same time as the measurement near Botriver

3. Finite element modelling with Comsol-Multiphysics

To enhance the understanding the depth, direction and spatial distribution of the return currents during a geomagnetic storm, a 3D finite element (FE) modelling is also proposed. The FE is introduced to address complexities posed by the Earth's geometry. COMSOL-Multiphysics FE Software is proposed to handle the FE modelling. FE modelling approximates a solution to a complex problem. The solution from an FE model may not be "exact" but it closely approximate a desired solution when analytical techniques are difficult to implement. Understanding the characteristics of GICs will aid in the comprehension of the nature of the return currents flowing in the power lines.

Modelling GICs involves two dependent steps. The first step involves the determining the horizontal electric field at the Earth's surface during the rapid geomagnetic variations during the storm. At this stage, the system configuration does not play a role in the characteristics of the induced field. A set of Maxwell's equation linking the magnetic and the electric field are the basis of the solution in this stage of modelling. To accomplish this level of modelling, the Earth's conductivity and the measured geomagnetic field variations or the magnetospheric-ionospheric

currents are regarded the crucial modelling inputs. The second stage of modelling involves calculating the GICs on a particular network. Various network parameters play a significant role on the magnitude of the GICs estimates. This means that, this stage of modelling can not be generalised but will differ with network configuration.

To test the application of the software to achieve the broader objective of modelling the characteristics of GICs in the power lines, certain validation tests have to be performed on the software. This begins with validation of the inputs such as the time varying magnetic field. This include comparing the results obtained from the simulations with solutions with theoretical results. Measured data are available from Hermanus. The data can be used to test designed simulation setup.

4. FE Preliminary results

A $20 \times 20 \times 1$ km block of $\sigma = 0.001$ S/m , $\epsilon = 1$, and $\mu_r = 1$, was built in the software. In this exercise, a plane wave was assumed and its -x component was used as the input in the model. A time varying magnetic field shown Figure 6, was applied on the surface of this block in the -x direction. The computation done was such that the magnitude of the induced current and electric field in the block can be simulated. The aim is to further expand the computation so that the spatial direction and depth of the currents can be simulated for an N layered Earth model.

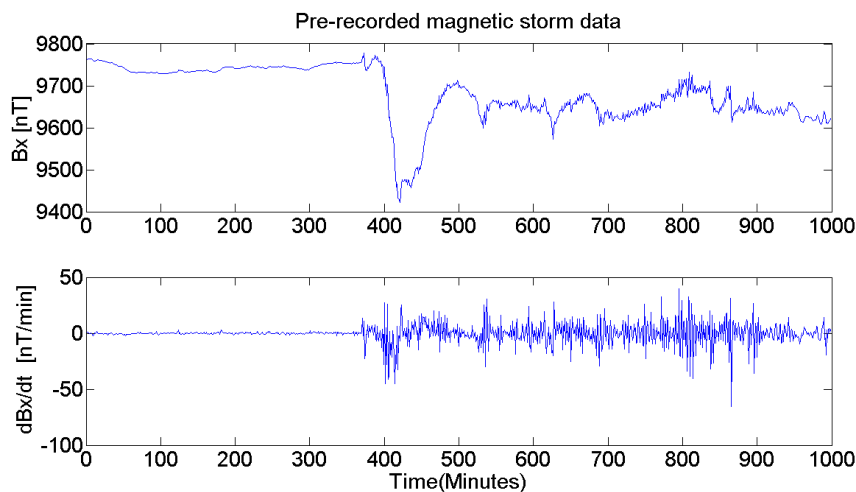

Figure 6. Pre-recorded magnetic data and corresponding dB/dt used as input in the model

From the results shown Figures 7 and 8, it can be noted that, the computed software results agree with ohm's law that relates current density and Electric field. Mathematically the law is represented as $J = \sigma E$ where J is the current density and E is the electric field. The constant of proportionality is the conductivity of the material which in this case is 0.001 S/m and is evident in the the two figures.

5. Conclusion

At this stage of the research, no significant results concerning the characteristics of GICs on power lines have been drawn. For the DMM technique, a permanent setup is under design to have longer period magnetic variations recordings. The longer the period of data recording the better will be the understanding of the variations at the site. Data from the Hermanus will be used for reference when analysing the data measured at the Botriver site.

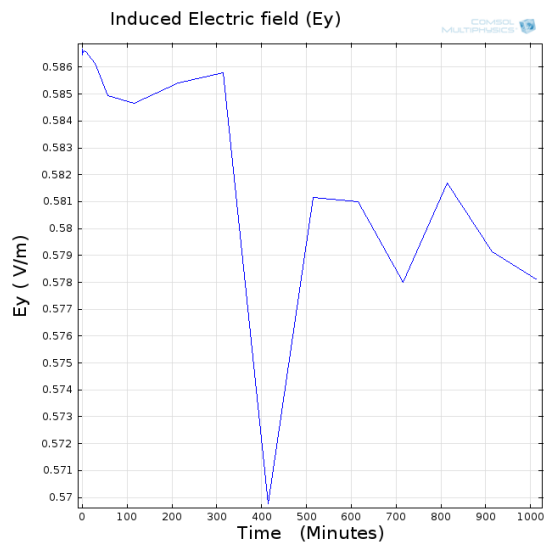

Figure 7. Electric Field strength induced within the block due to magnetic field variation

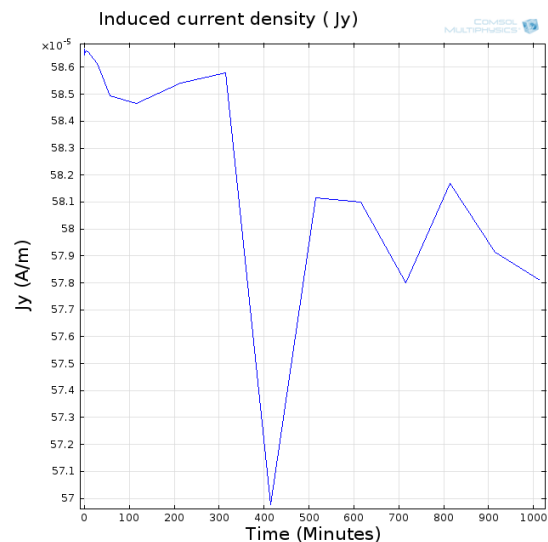

Figure 8. Induced current density within the block due to magnetic field variation

Concerning the finite element modelling, the different geometry setups are currently being studied and designed so that sensible results can be drawn from the simulations. The software package has so far proved to be suitable for the proposed study. COMSOL Multiphysics offers the platform to simulate electric and magnetic field at the same time. This is achieved through the AC/DC module.

Acknowledgments

The material and financial support for the research is provided by South African National Space Agency (SANSa), Space Science Directorate and the French South African Institute of Technology (F'SATI).

References

- [1] Koskinen H, Transknen E, Pijola R, Pulkkinen A, Dyer C, Rodgers D, Cannon P, Mandeville J and Boscher D 2001 *ESA space weather study* **2**
- [2] Pijola R 2000 *IEEE, Transactions on Plasma Science*. **28** 1867–1873
- [3] Boteler D H, Pijola R and Nevanlinna H 1998 *Advances in Space Research* **22** 17–27
- [4] Gummow R A 2002 *Journal of Atmospheric and Solar-Terrestrial Physics* **64** 1755–1764
- [5] Molinski T S 2000 *Astrophysics and Solar Terrestrial Physics* **64** 1765–1778
- [6] Czech M P, Charo S, Hynk H and Dutel A 1989 (San Francisco, California) pp 36–60
- [7] Viljanen A T, Pijola R J, Pajunpaa R and Pulkkinen A A 2009 (Saint-Petersburg, Russia) pp 227–230 june 16-19, 2009.
- [8] Marshall R A, Gorniak H, van der Walt T, Waters C L, Sciffer M D, Miller M, Dalzell M, Daly T, Pouferis G, Hesse G and Wilkinson P J 2012 *Space Weather*
- [9] Trivedi N B, Vitorello I, W Kabata, Padilha A, Bologna M S, de Padua M B, A P Soares, G S Luz, de A Pinto F, Pijola R and Viljanen A 2007 *Space Weather* **5** 1–10
- [10] Liu C, Liu L, Pijola R J and Wang Z 2009 *Space Weather* **7**
- [11] Torta J M, Serrano L, Regué R J, Sánchez A M and Roldán E 2012 *Space Weather* **10** 1–11
- [12] Koen J 2002 *Geomagnetically Induced Currents in the Southern African Transmission Network* Ph.D. thesis University of Cape Town Cape Town, South Africa